

# Verdichtingsparels

Cubes, Amsterdam

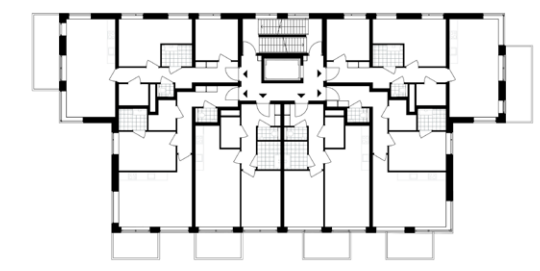

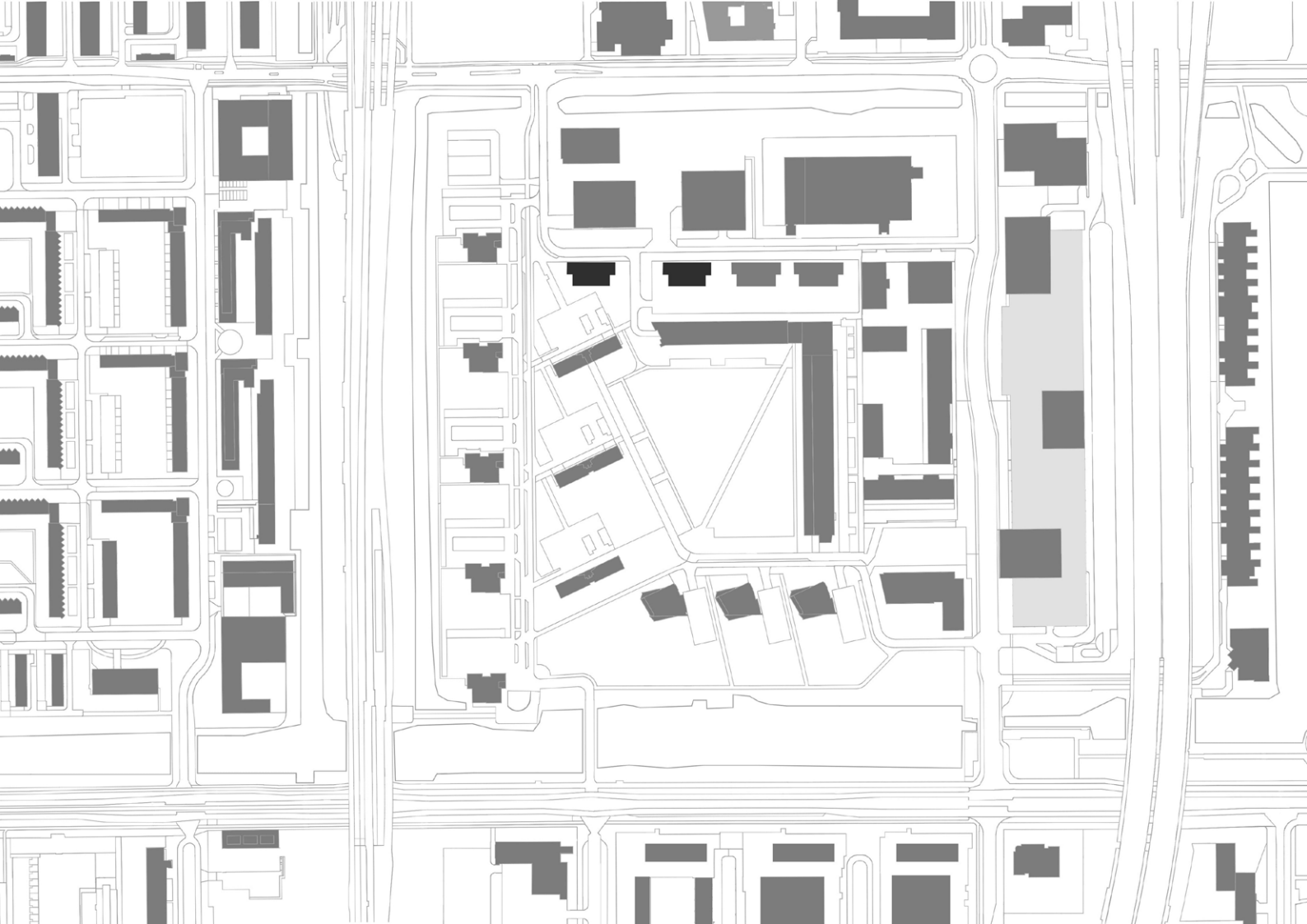



+2

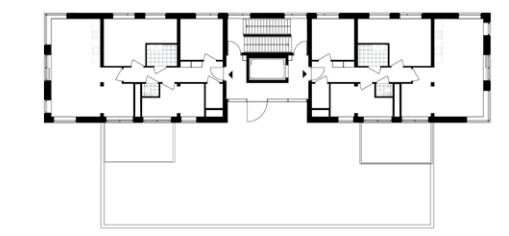

+5

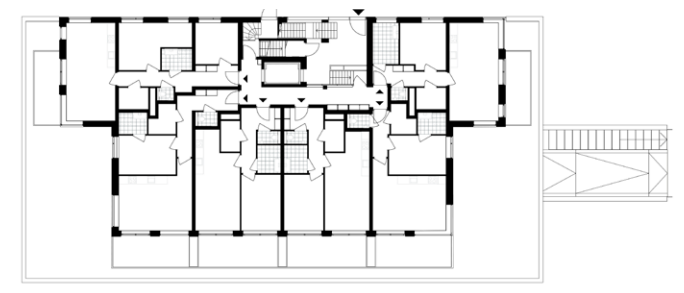

0

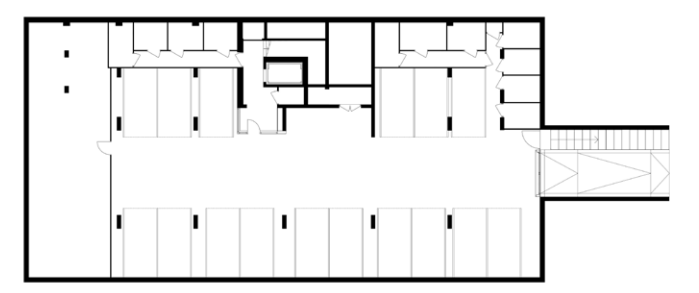

-1





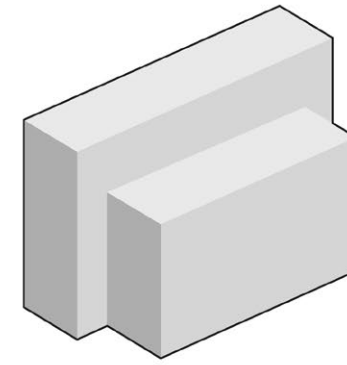

Basisvolume

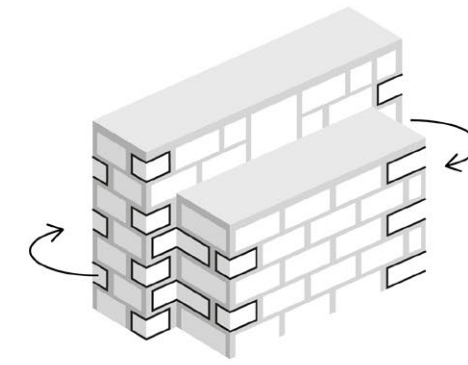

Gevelgrid geeft dynamisch beeld

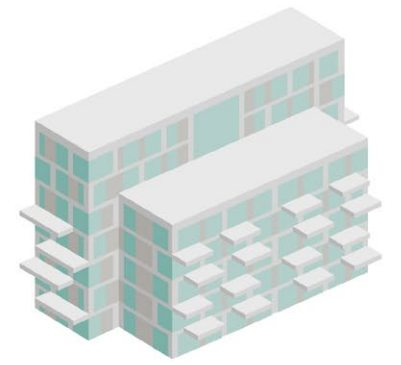

Balkons en ramen binnen grid





